

M331 Industrial Cellular Router

Quick Installation Guide

Version: 1.00

Install the SIM Card

STEP 1: Before inserting or removing the SIM card, ensure that the power has been turned off, or the power connector has been removed from the M331 Cellular Router.

STEP 2: Using a screwdriver to remove the metal protective cover first, insert the SIM card into the card slots. The cut-off edge of the SIM card on upper SIM slot 1 (lower SIM slot 2) is to the left (right).

STEP 3: Push the SIM card and lightly press it to lock into the slot.

STEP 4: Remove the SIM card, lightly press it and it will pop out of the slot.

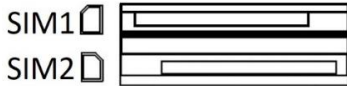

NOTE:

- Please use the industrial SIM card operating from -40°C to +105°C to ensure proper cellular router operation.

LED Indicators

The following table explains the LED indicators on the front panel.

LED	Off	On	Slow	Fast	Heartbeat
SYS	Power down	Power up	N/A	N/A	N/A
SIM	Not working	Connected	Connecting	Error	Reading
Signal	No signal	High signal	Medium signal	Low signal	N/A

Reset Button

Function	Operation
Reset	Press the button for 1 seconds.
Reset to default setting	Press the button for more than 5 seconds.

Connecting I/O Ports

There are four terminals on the terminal block with two terminals used for digital input and two terminals used for digital output.

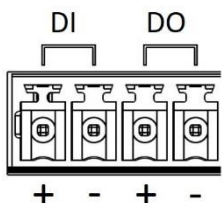

Pin	Description
DI +	Digital Input
DI -	
DO +	Digital Output
DO -	

DI: Low (+0 to +3V) / High (+8 to +40V)
DO: Open Collect (maximum 30V/300mA)

LED Indicators of Ethernet Port

There are two LED indicators for each of three LAN ports and one WAN port.

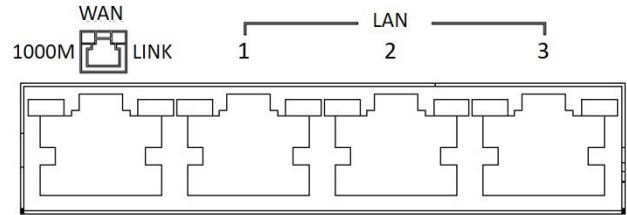

LED	Blinking	On	Off
1000M	N/A	1000Mbps	10/100Mbps
LINK	Data Transmitting	LINK UP	LINK DOWN

RS-232 and RS-485 pinouts

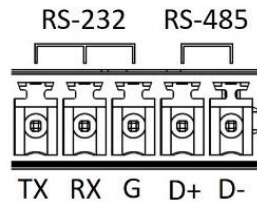

NOTE:

- RS-232 and RS-485 share the common ground pin "G".

RS-232

Pin	Signal	Direction
TX	Transmit Data	Output
RX	Receive Data	Input
G	Signal Ground	-

RS-485

Pin	Description
D +	Serial Port, Data+ (A) wire
D -	Serial Port, Data- (B) wire
G	Signal Ground

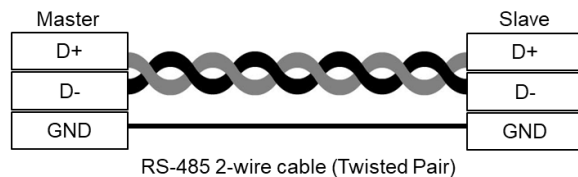

Connecting the Power Supply

Powering the M331 Cellular Router is by either a terminal block or a DC jack.

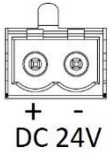

One terminal block is on the front panel.

The power input voltage range is 8 ~ 26 VDC.

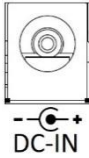

One DC Jack is on the front panel.

The power input voltage is 12 VDC.

Antenna Installation

Three SMA connectors placed on the left panel are for connecting to external LTE and GPS antennas.

- MAIN: for LTE Transmit and Receive
- AUX: for optional LTE Receive for better downstream speed
- GPS: for GPS

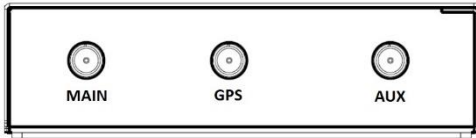

DIN-rail Mounting

STEP 1: Use the screws to install the DIN-rail kit to attach at the rear side of the device.

NOTE:

- Three screw types are flat head M3 x 4 mm.

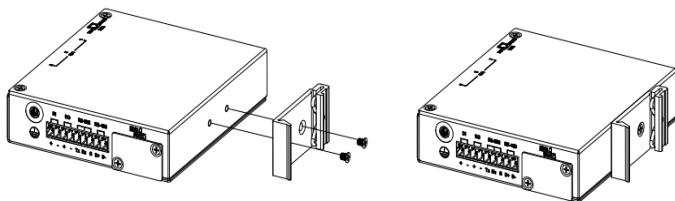

STEP 2: Hook the unit onto the DIN-rail.

STEP 3: Push the bottom of the unit towards the DIN-rail until it locks in place.

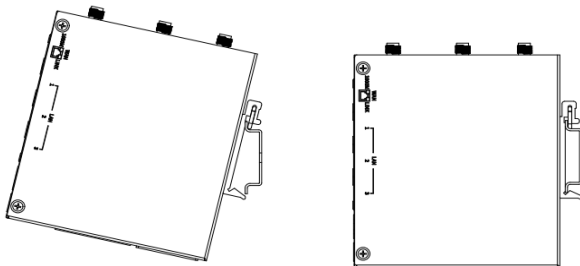

Wall Mounting

STEP 1: At the bottom side of the device, use two screws to install each bracket.

NOTE:

- Each screw type is flat head M3 x 6 mm.

STEP 2: Use the screws to attach the bracket of the device for wall mounting.

NOTE:

- These screws are not included in the package. The head of each screw is less than 7 mm in diameter, the shaft is less than 3 mm in diameter, and the length is less than 10 mm in diameter.

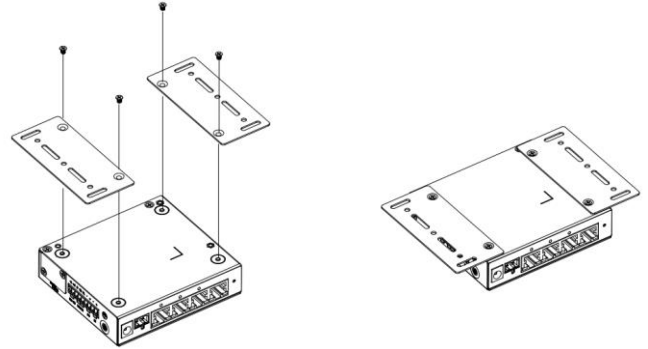

Setup

(1) Access the Web Configurator

- Type the default URL <http://192.168.1.1> in your web browser.
- In the login page, enter the default username **root** and the default password **2wsx#EDC** and then click the **Login** button.

(2) Change Password

Go to the **Management -> Administration** and enter the desired **New Password** and then scroll down the page and click the **Apply** button.

NOTE

- Please scan below QR Code to download online resources.

Download link: <https://www.proscend.com/en/product/M331.html>



M331