

708EPI-DC

Industrial 8-Port PoE Long Reach Switch

Quick Installation Guide

Version: 2.00

Overview

The 708EPI-DC PoE Switch features 8 pairs of Long Reach Ethernet connections in cooperation with the 101EPI. Each pair carries Ethernet traffic and power over an Ethernet cable up to 800 meters. The 708EPI-DC is designed to locate at network side where the 101EPI is located at the remote side.

LED Indicators

Each LED indicator on the front panel is described in the following table.

LED	Color	LED	Description
PWR	Green	On	Device Power On.
		Off	Device Power Off.
SYS	Green	On	System is working.
		Off	System is off.
		Blinking	Device Error.
PoE1~8	Green	On	Powered Device Connected.
		Off	Powered Device Disconnected.
UPLINK	Green	On	1000Mbps UPLINK LINK UP.
		Off	1000Mbps UPLINK LINK DOWN.
		Blinking	1000Mbps Data Transmitting.
	Yellow	On	100/10Mbps UPLINK LINK UP.
		Off	100/10Mbps UPLINK LINK DOWN.
		Blinking	100/10Mbps Data Transmitting.
LINE 1~8	Green	On	100Mbps LINE LINK UP.
		Off	LINE LINK DOWN.
		Blinking	100Mbps Data Transmitting.
	Yellow	On	10Mbps LINE LINK UP.
		Off	LINE LINK DOWN.
		Blinking	10Mbps Data Transmitting.

LINE Port Pin Assignment

8-pin RJ45

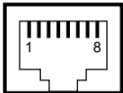

The LINE interfaces of the 708EPI-DC are standard 8-pin RJ45 connectors. The following tables display the pinouts.

MDI Port Pinouts		MDI-X Port Pinouts	
Pin	Description	Pin	Description
1	TX+	1	RX+
2	TX-	2	RX-
3	RX+	3	TX+
4	Not used	4	Not used
5	Not used	5	Not used
6	RX-	6	TX-
7	Not used	7	Not used
8	Not used	8	Not used

The PoE pinouts of the LINE interfaces are as below when 8 wires are connected.

PoE Pinouts			
Pin	Description	Pin	Description
1	V+	5	V+
2	V+	6	V-
3	V-	7	V-
4	V+	8	V-

The PoE pinouts of the LINE interfaces are as below when 4 wires are connected.

PoE Pinouts			
Pin	Description	Pin	Description
1	V+	5	Not used
2	V+	6	V-
3	V-	7	Not used
4	Not used	8	Not used

Connecting the Power Supply

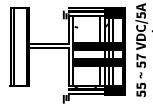

- The power input interface is the 2-pin terminal block (+, -) on the front panel and is provided the power input voltage 55 ~ 57 VDC/5A from the power supply.
- Insert the positive and negative wires into V+ and V- contact on the terminal block and tighten the wire-clamp screws to prevent the wires from being loosened.

Ground Connection

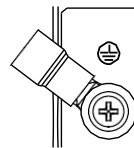

To prevent the effects of noise from electromagnetic interference (EMI), run the ground connection from the ground screw to the grounding surface before connecting the devices.

Rest Button

Reset button allows you to reboot the unit or restore to factory default setting.

Function	Operation
Reboot	Press the button for 1 second
Restore to factory default setting	Press the button for more than 5 seconds

DIN-rail Mounting

STEP 1: Use the screws to install the DIN-rail kit to attach at the rear side of the device.

NOTE: Three screw types are flat head M3 x 4 mm.

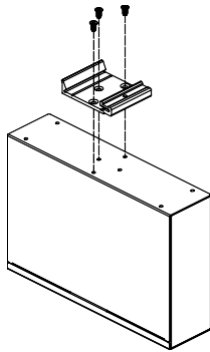

STEP 2: Hook the unit onto the DIN-rail.

STEP 3: Push the bottom of the unit towards the DIN-rail until it locks in place.

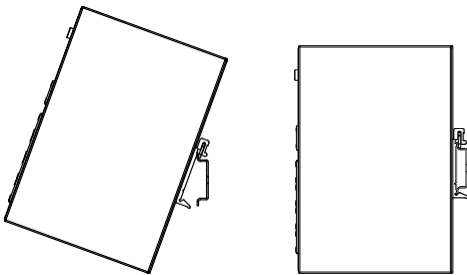

Wall Mounting

STEP 1: At the bottom side of the device, use two screws to install each bracket.

NOTE: Each screw type is flat head M3 x 4 mm.

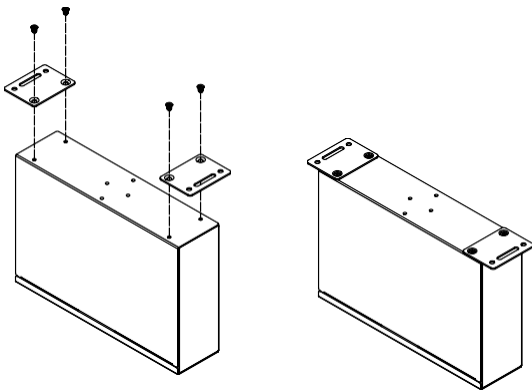

STEP 2: Use the screws to attach the bracket of the device for wall mounting.

NOTE: These screws are not included in the package. The head of each screw is less than 7 mm in diameter, the shaft is less than 3 mm in diameter, and the length is less than 10 mm in diameter.

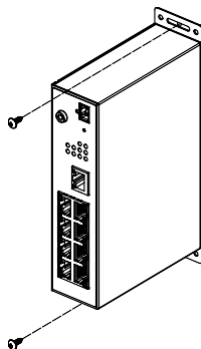

Setup

(1) Access the Web Configurator via UPLINK port or LINE ports.

STEP 1: Enter the default IP address **192.168.1.1** as URL in your web browser.

STEP 2: Please enter the default username **root** and the default password **2wsx#EDC**.

STEP 3: Click Login button.

(2) Change the default password.

Go to **User** setting and reset your new password and then click **Apply** button.

NOTE: The default password should be changed after configuration. Please avoid using easy to guess passwords (e.g., root, 1234...).

⚠ ATTENTION: Safety Warning

- Disconnect all power from devices before attempting installation.
- This device is intended for installation only in restricted access locations as defined where both these conditions apply:
 - Access is through the use of a lock or tool and key, or other means of security, and is controlled by the authority responsible for the location.
 - Access can only be gained by service persons or by users who have been instructed about the reasons for the restrictions applied to the location and about any precautions that shall be taken.
- All electric installations must be carried out in accordance with local and national regulations.
- Do not work on the system, connect or disconnect cables during periods of lightning activity.
- The equipment must be connected to earth.
- Shield of RJ45 cables has to be connected to the same earth potential as the equipment.
- Please remove the ground connection lastly if you need to remove the device after installation.
- If the LINE interface is used for the connection between two buildings, all necessary protective measures must be ensured externally.
- This equipment relies on the building's installation for short-circuit (overcurrent) protection. Ensure that a fuse or circuit breaker no larger than 5A is used.

NOTE

- Please scan below QR Code to download online resources. Download Link: <https://www.proscend.com/en/product/708EPI-DC.html>



708EPI-DC