

850G Series Industrial Ethernet Switch (850G-12PI, 850G-14I, 850G-12I)



Introduction

Proscend 850G Series Industrial Ethernet Switch enables the legacy Industrial network to evolve to full Gigabit Ethernet network, the 850G series not only offers 1000Mbps Ethernet speed over copper and fiber, but also perfect quality of services, network security and resilience, as well as reducing network response time for mission critical applications such as video security, transportation, energy, etc.

The 850G Series consists of three models featuring full Gigabit Ethernet, full manageability, network resilience, wide temperature, DIN-rail mounting, fiber uplinks, and optional Power-over-Ethernet with 30 watt per Gigabit port. The numbers of 10/100/1000Base-T port ranges from 8 to 10 for connecting industrial computer, HMI, PLC, IP camera, etc. The four SFP slots supporting DDM (Digital Diagnostic Monitoring) function for predictive maintenance are used to work with SFP (Small form-factor pluggable) fiber transceivers to scale out modern industrial networks with ring, daisy chain or tree topologies.

Features

- Operating temperature -40°C ~ 75°C
- Total PoE power budget 240W (850G-12PI)
- Rapid Ring fail-over protection (< 20 ms)
- IPv6 manageable
- Jumbo frames
- DIN-rail and wall-mounting options

Application

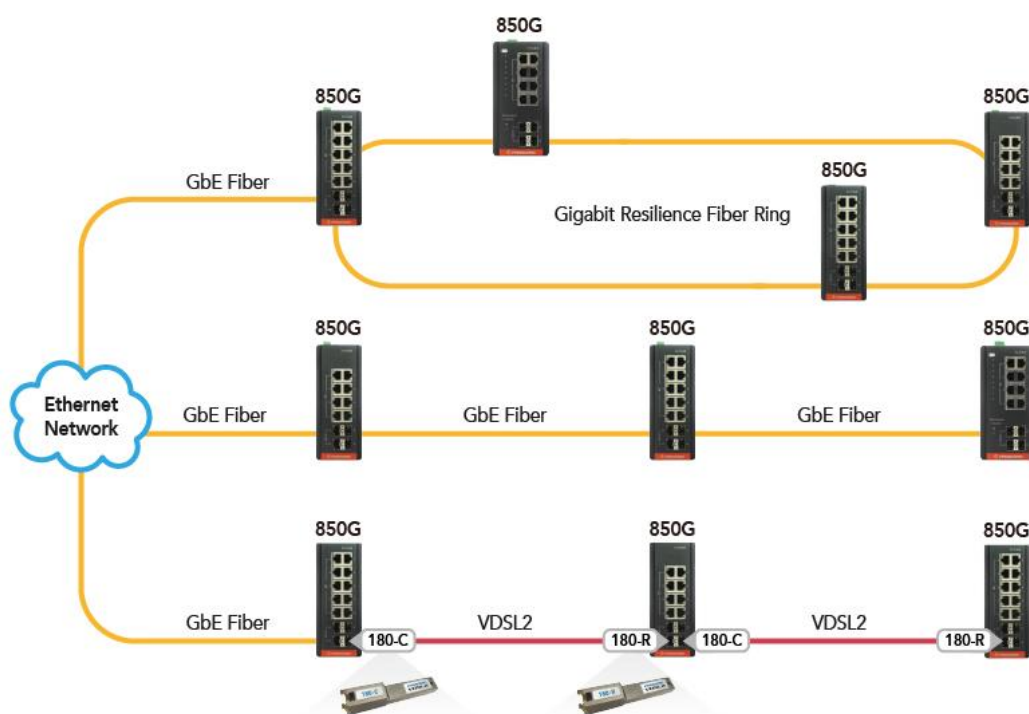

Specifications

Interfaces

- 850G-12I, 850G-12PI LAN port: 10/100/1000Base-T x 8, RJ45
- 850G-14I LAN port : 10/100/1000Base-T x 10, RJ45
- LAN port Isolation: 1500 VRMS 1 minute
- Uplink port: SFP slot x 4, support 100M/1000Mbps transceivers
- Console port: RS-232, baud rate 115.2kbps
- Dual power input and alarm relay: 6-pin terminal block
- Alarm relay output: 0.5A @ 24 VDC

Network Resilience

- Fast failover protection ring: Link loss recovery < 20 ms
- IEEE 802.1D STP, IEEE 802.1w RSTP, IEEE 802.1s MSTP
- LACP: Static trunk or Dynamic

Protocols & Security

- Port-based and policy-based VLAN, Q in Q
- IEEE 802.1ab Link Layer Discovery Protocol (LLDP)
- IEEE 802.1p QoS, IGMP, Port-based traffic shaping
- IP and MAC-based access control
- IEEE 802.1X authentication Network Access Control
- Multicast / Broadcast / Flooding Storm Control

Management

- Web-based Management, HTTPS, CLI, Telnet, SSH
- SNMP v1, v2c, v3, RMON, Syslog
- HTTP/TFTP firmware upgrade
- DHCP client, Snooping, Relay Agent with Option 82
- NTP
- DDM (Digital Diagnostic Monitoring) for SFP transceiver
- PoE scheduling, power control

Mechanical

- Dimension (H x D x W): 154 x 109 x 61mm (850G-12I/850G-14I)
- Dimension (H x D x W): 154 x 128 x 77mm (850G-12PI)
- Weight: 1110 g (850G-12I/850G-14I)
- Weight: 1410 g (850G-12PI)
- DIN-rail and wall mounting
- IP30

Power

- Dual power inputs with reverse power protection
- 12-58 VDC (850G-12I/850G-14I), 54-58 VDC (850G-12PI)
- System power consumption: 17W, PoE power budget: 240W
- Transient protection: > 15,000 watts peak

LED Indicators

- Power input, System alarm
- Ethernet LAN port Link & Speed
- PoE output (850G-12PI)
- Ring Master, Ring Fail

Environment & Regulatory Compliance

- Operation temperature: -40 to +75°C (cold startup at -40°C)
- Storage temperature: --40 to +85 °C
- Humidity (non-condensing): 5 to 95% RH
- Vibration, shock & freefall: IEC68-2-6, -27, -32
- EMC: FCC Part 15, CISPR 22 (EN55022) Class A, IEC61000-4
- Electrical safety: CE, CSA, EN61010-1
- EN50121-4, optional NEMA TS2, C1D2, UL508
- RoHS (Pb free) and REACH compliant
- MTBF: > 25 years

Dimensions

850G-12PI

Unit: mm [inch]

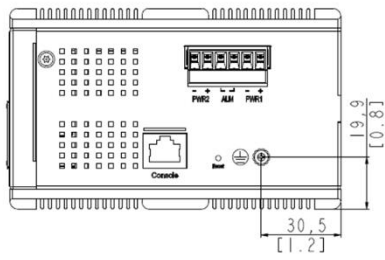

Top view

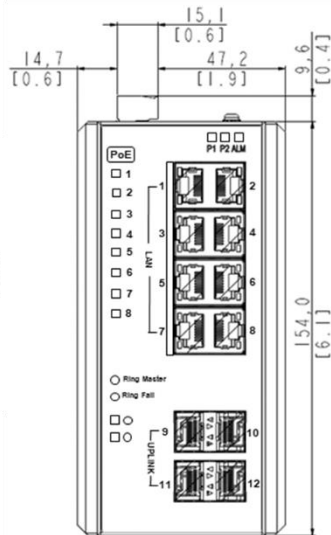

Front view

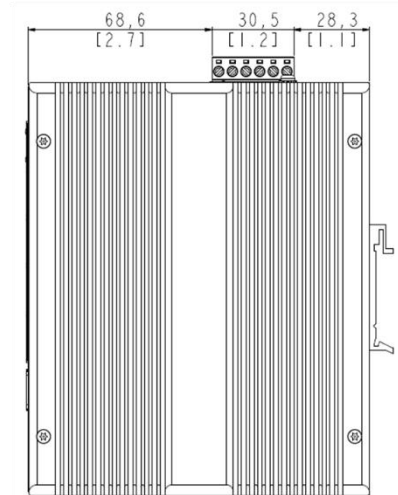

Side view

850G-14I

Unit: mm [inch]

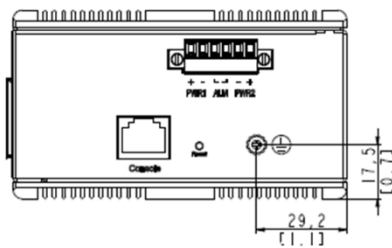

Top view

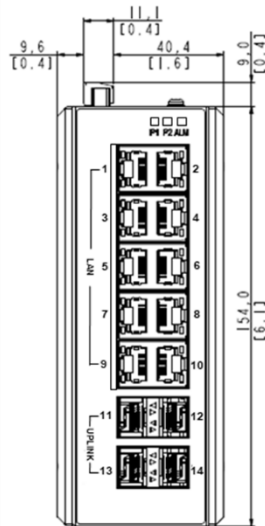

Front view

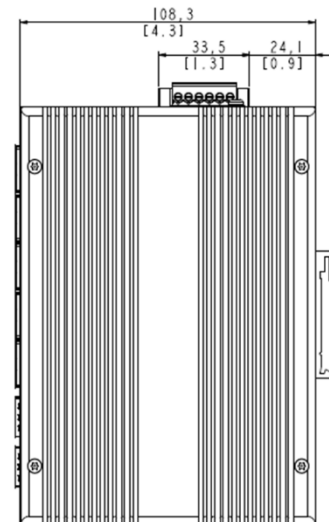

Side view

850G-12I

Unit: mm [inch]

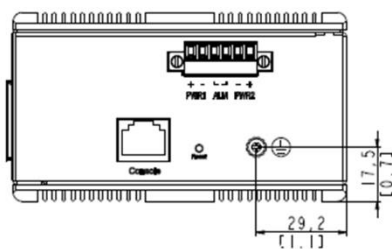

Top view

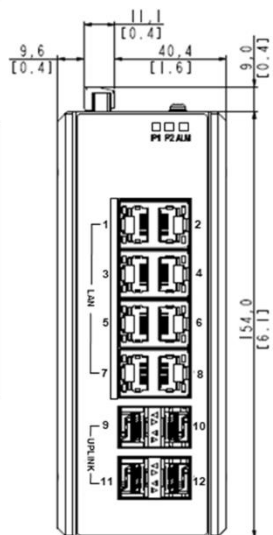

Front view

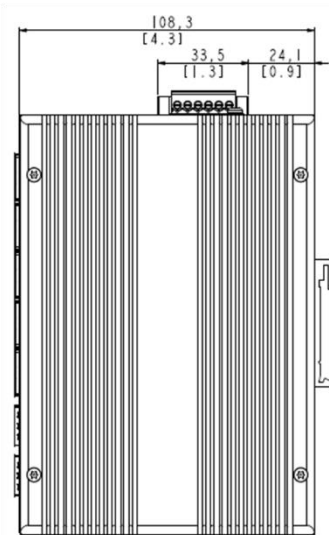

Side view

Ordering Information

Model Name	Description
850G-12PI	Industrial 12-Port GbE Managed PoE Switch (802.3at PoE GbE x 8, GbE SFP x 4)
850G-14I	Industrial 14-Port GbE Managed Switch (GbE x 10, GbE SFP x 4)
850G-12I	Industrial 12-Port GbE Managed Switch (GbE x 8, GbE SFP x 4)

NOTE: Features and specifications are subject to change without prior notice.